

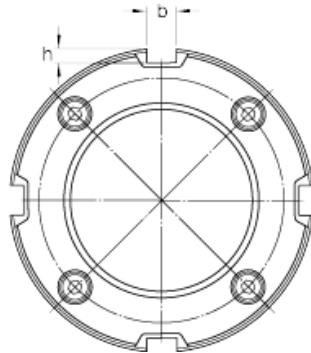

NTN bearing de Mexico, S.A.

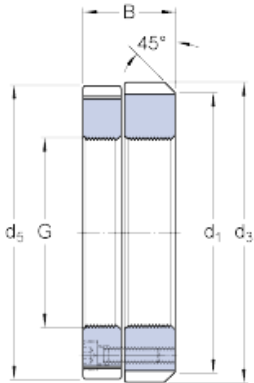

skf KMD 8 Precision lock nuts with axial locking screws, Precision lock nuts

Bearing No. KMD 8

G	M 40x1.5
d ₁	58 mm
B	22 mm
d ₃	63 mm
d ₅	62 mm
b	6 mm
h	2.5 mm
Mass	0.27 kg
Associated spanner (Hook spanner in accordance with DIN 1810)	HN 8-9
Grub (set) / Locking screw size	M 4
Recommended tightening torque	4.2 N · m

KMD 8 Bearing 2D drawings and 3D CAD models