

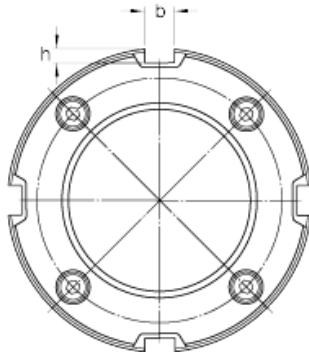

NTN bearing de Mexico, S.A.

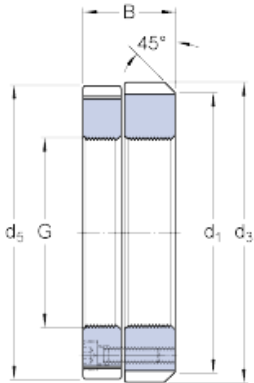

skf KMD 14 Precision lock nuts with axial locking screws, Precision lock nuts

Bearing No. KMD 14

G	M 70x2
d ₁	90 mm
B	28 mm
d ₃	95 mm
d ₅	94 mm
b	8 mm
h	3.5 mm
Mass	0.67 kg
Associated spanner (Hook spanner in accordance with DIN 1810)	HN 14
Grub (set) / Locking screw size	M 5
Recommended tightening torque	8.4 N · m

KMD 14 Bearing 2D drawings and 3D CAD models